

OWNER'S MANUAL

AIR CONDITIONER

Please read this manual carefully before operating your set and retain it for future reference.

※ This product contains Fluorinated Greenhouse Gases. (R410A)

WALL MOUNTED

Original instruction

[Representative] LG Electronics Inc. EU Representative : LG Electronics European Shared Service Center B.V.
Krijgsman 1, 1186 DM Amstelveen, The Netherlands

[Manufacturer] LG Electronics Inc. Changwon 2nd factory 84, Wanam-ro, Seongsan-gu, Changwon-si,
Gyeongsangnam-do, KOREA



P/NO : MFL67482005

www.lg.com

ENGLISH

ITALIANO

ESPAÑOL

FRANÇAIS

DEUTSCH

ΕΛΛΗΝΙΚΑ

ČEŠTINA

NETERLANDS

POLSKI

IMBA ROMÂNĂ

TIPS FOR SAVING ENERGY

Here are some tips that will help you minimize the power consumption when you use the air conditioner. You can use your air conditioner more efficiently by referring to the instructions below:

- Do not cool excessively indoors. This may be harmful for your health and may consume more electricity.
- Block sunlight with blinds or curtains while you are operating the air conditioner.
- Keep doors or windows closed tightly while you are operating the air conditioner.
- Adjust the direction of the air flow vertically or horizontally to circulate indoor air.
- Speed up the fan to cool or warm indoor air quickly, in a short period of time.
- Open windows regularly for ventilation as the indoor air quality may deteriorate if the air conditioner is used for many hours.
- Clean the air filter once every 2 weeks. Dust and impurities collected in the air filter may block the air flow or weaken the cooling / dehumidifying functions.

For your records

Staple your receipt to this page in case you need it to prove the date of purchase or for warranty purposes. Write the model number and the serial number here:

Model number : _____

Serial number : _____

You can find them on a label on the side of each unit.

Dealer's name : _____

Date of purchase : _____

IMPORTANT SAFETY INSTRUCTIONS

READ ALL INSTRUCTIONS BEFORE USING THE APPLIANCE.

Always comply with the following precautions to avoid dangerous situations and ensure peak performance of your product

⚠ WARNING

It can result in serious injury or death when the directions are ignored

⚠ CAUTION

It can result in minor injury or product damage when the directions are ignored

⚠ WARNING

- Installation or repairs made by unqualified persons can result in hazards to you and others.
- Installation work must be performed in accordance with the National Electric Code by qualified and authorized personnel only.
- The information contained in the manual is intended for use by a qualified service technician familiar with safety procedures and equipped with the proper tools and test instruments.
- Failure to carefully read and follow all instructions in this manual can result in equipment malfunction, property damage, personal injury and/or death.

Installation

- Do not use a defective or underrated circuit breaker. Use the correctly rated breaker and fuse. There is risk of fire or electric shock.
- For electrical work, contact the dealer, seller, a qualified electrician, or an Authorized Service Center. Do not disassemble or repair the product by yourself. There is risk of fire or electric shock.
- Always ground the product as per the wiring diagram. Do not connect the ground wire to gas or water pipes lightning rod or telephone ground wire. There is risk of fire or electric shock.
- Install the panel and the cover of control box securely. There is risk of fire or electric shock due to dust, water etc.
- Use the correctly rated breaker or fuse. There is risk of fire or electric shock.

- Do not modify or extend the power cable. If the power cable or cord has scratches or skin peeled off or deteriorated then it must be replaced. There is risk of fire or electric shock.
- For installation, removal or reinstall, always contact the dealer or an Authorized Service Center. There is risk of fire, electric shock, explosion, or injury.
- Do not install the product on a defective installation stand. Be sure that the installation area does not deteriorate with age. It may cause product to fall.
- Never install the outdoor unit on a moving base or a place from where it can fall down.
The falling outdoor unit can cause damage or injury or even death of a person.
- In outdoor unit the step-up capacitor supplies high voltage electricity to the electrical components. Be sure to discharge the capacitor completely before conducting the repair work.
An charged capacitor can cause electrical shock.
- When installing the unit, use the installation kit provided with the product. Otherwise the unit may fall and cause severe injury.
- Indoor/outdoor wiring connections must be secured tightly and the cable should be routed properly so that there is no force pulling the cable from the connection terminals. Improper or loose connections can cause heat generation or fire.
- Safely dispose off the packing materials. Like screws, nails, batteries, broken things etc after installation or svc and then tear away and throw away the plastic packaging bags. Children may play with them and cause injury.
- Be sure to check the refrigerant to be used. Please read the label on the product. Incorrect refrigerant used can prevent the normal operation of the unit.

Operation

- When the product is soaked (flooded or submerged) in water, contact an Authorized Service Center for repair before using it again. There is risk of fire or electric shock.
- Be sure to use only those parts which are listed in the svc parts list. Never attempt to modify the equipment. The use of inappropriate parts can cause an electrical shock, excessive heat generation or fire.

- Do not touch , operate, or repair the product with wet hands. Hold the plug by hand when taking out. There is risk of electric shock or fire.
- Do not place a heater or other heating appliances near the power cable. There is risk of fire and electric shock.
- Do not allow water to run into electric parts. Install the unit away from water sources. There is risk of fire, failure of the product, or electric shock.
- Do not store or use or even allow flammable gas or combustibles near the product. There is risk of fire.
- Do not use the product in a tightly closed space for a long time. Perform ventilation regularly. Oxygen deficiency could occur and hence harm your health.
- Do not open the front grille of the product during operation. (Do not touch the electrostatic filter, if the unit is so equipped.) There is risk of physical injury, electric shock, or product failure.
- If strange sound, smell or smoke comes from product. Immediately turn the breaker off or disconnect the power supply cable. There is risk of electric shock or fire.
- Ventilate the product room from time to time when operating it together with a stove, or heating element etc. Oxygen deficiency can occur and hence harm your health.
- When the product is not to be used for a long time, disconnect the power supply plug or turn off the breaker. There is risk of product damage or failure, or unintended operation.
- Take care to ensure that nobody especially kids could step on or fall onto the outdoor unit. This could result in personal injury and product damage.
- Take care to ensure that power cable could not be pulled out or damaged during operation. There is risk of fire or electric shock.
- Do not place ANYTHING on the power cable. There is risk of fire or electric shock.
- When flammable gas leaks, turn off the gas and open a window for ventilation before turning on the product. Do not use the telephone or turn switches on or off. There is risk of explosion or fire.
- Make sure to ventilate sufficiently when this air conditioner and a heating appliance such as a heater are used simultaneously. Failure to do so may result in fire, serious injury, or product failure.

 **CAUTION****Installation**

- Two or more people must lift and transport the product. Avoid personal injury.
- Do not install the product where it will be exposed to sea wind (salt spray) directly. It may cause corrosion on the product.
- Install the drain hose to ensure that the condensed water is drained away properly. A bad connection may cause water leakage.
- Keep level even when installing the product. To avoid vibration or noise.
- Do not install the product where the noise or hot air from the outdoor unit could damage or disturb the neighborhoods. It may cause a problem for your neighbors and hence dispute.
- Always check for gas (refrigerant) leakage after installation or repair of product. Low refrigerant levels may cause failure of product.

Operation

- Do not use the product for special purposes, such as preserving foods, works of art, etc. It is a consumer air conditioner, not a precision refrigeration system. There is risk of damage or loss of property.
- Do not block the inlet or outlet of air flow. It may cause product failure.
- Use a soft cloth to clean. Do not use harsh detergents, solvents or splashing water etc. There is risk of fire, electric shock, or damage to the plastic parts of the product.
- Do not touch the metal parts of the product when removing the air filter. There is risk of personal injury.
- Do not step on or put anything on the product. (outdoor units) There is risk of personal injury and failure of product.
- Always insert the filter securely after cleaning. Clean the filter every two weeks or more often if necessary. A dirty filter reduces the efficiency.
- Do not insert hands or other objects through the air inlet or outlet while the product is operating. There are sharp and moving parts that could cause personal injury.
- Be cautious when unpacking and installing the product. Sharp edges could cause injury.

- If the refrigerant gas leaks during the repair, do not touch the leaking refrigerant gas. The refrigerant gas can cause frostbite (cold burn).
- Do not tilt the unit when removing or uninstalling it. The condensed water inside can spill.
- Do not mix air or gas other than the specified refrigerant used in the system. If air enters the refrigerant system, an excessively high pressure results, causing equipment damage or injury.
- If the refrigerant gas leaks during the installation, ventilate the area immediately. Otherwise it can be harmful for your health.
- Dismantling the unit, treatment of the refrigerant oil and eventual parts should be done in accordance with local and national standards.
- Replace the all batteries in the remote control with new ones of the same type. Do not mix old and new batteries or different types of batteries. There is risk of fire or product failure.
- Do not recharge or disassemble the batteries. Do not dispose of batteries in a fire. They may burn or explode.
- If the liquid from the batteries gets onto your skin or clothes, wash it well with clean water. Do not use the remote if the batteries have leaked. The chemicals in batteries could cause burns or other health hazards.
- If you swallow the battery fluid from a leak, wash out the inside of your mouth thoroughly and then consult a doctor. Failure to do so may result in serious health complications.
- Do not let the air conditioner run for a long time when the humidity is very high and a door or a window is left open. Moisture may condense and wet or damage furniture.
- Do not expose your skin or kids or plants to the cool or hot air draft. This could harm to your health.
- Do not drink the water drained from the product. It is not sanitary and could cause serious health issues.
- Use a firm stool or ladder when cleaning, maintaining or repairing the product at an height. Be careful and avoid personal injury.

TABLE OF CONTENTS

2 TIPS FOR SAVING ENERGY

3 IMPORTANT SAFETY INSTRUCTIONS

9 BEFORE USE

- 9 Components

12 BASIC FUNCTIONS

- 12 Cooling your room
- 12 Heating your room
- 12 Removing humidity
- 13 Airing your room
- 13 Adjusting the fan speed
- 13 Adjusting the air flow direction
- 13 Setting the timer

15 ADVANCED FUNCTIONS

- 15 Changing room temperature quickly
- 15 Indoor air purification
- 16 Auto Changeover Mode
- 16 Display screen brightness
- 16 Operating the air conditioner without the remote control
- 17 Restarting the air conditioner automatically
- 17 Mode Lock setting

18 MAINTENANCE

- 19 Cleaning the Dual Protection Filter
- 19 Cleaning the Triple filter(Optional)
- 19 Cleaning the 3M filter(Optional)

20 TROUBLESHOOTING

- 20 Self-diagnosis function
- 20 Before requesting service

BEFORE USE

Components

Indoor unit

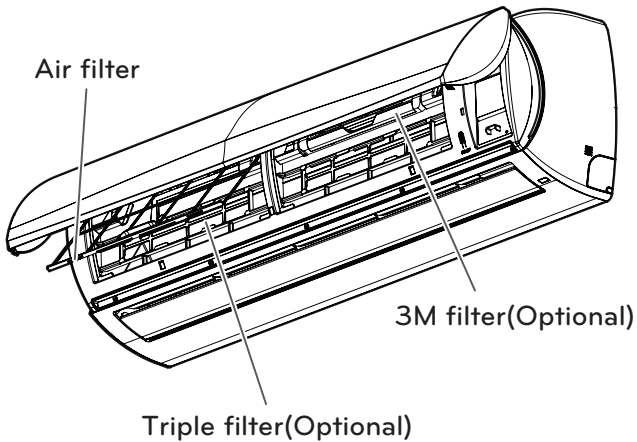
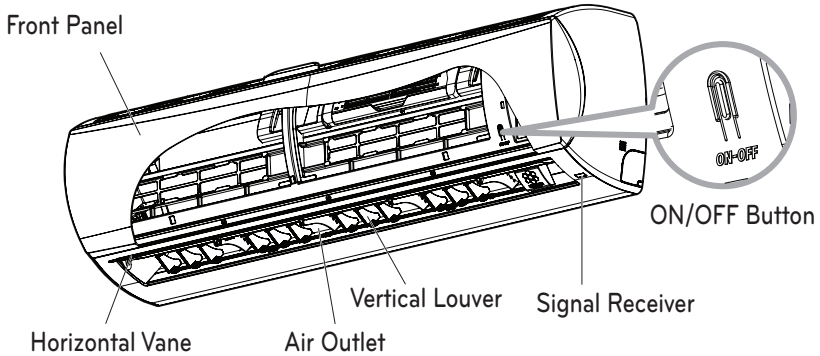

* The feature can be changed according a type of model.

NOTE

The number of operation lamps and their locations may vary, depending on the model of the air conditioner.

Wireless remote control

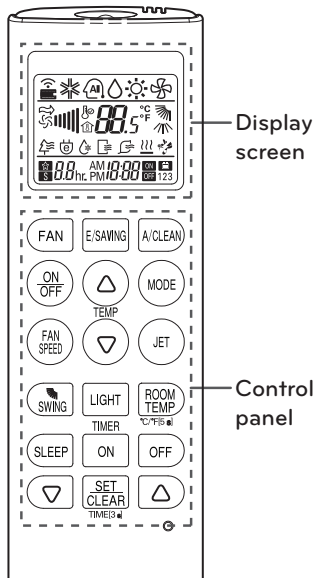

Control panel	Display screen	Description
		AIR CIRCULATION BUTTON Used to circulate the room air without cooling or heating.
		Sleep mode auto button* : Sets the sleep mode auto operation.
		Temperature adjustment buttons : Adjusts the room temperature when cooling and heating.
	-	On/Off button : Turns the power on/off.
		Indoor fan speed button : Adjusts the fan speed.
		Operation mode selection button* : Selects the operation mode. Cooling operation (❄️) / Auto operation or auto changeover (🌬️) / Dehumidifying operation (💧) / Heating operation (🔥)
		Jet cooling/heating button* : Warms up or cools down the indoor temperature within a short period of time.
		Air flow direction button* : Adjusts the air flow direction vertically.
		Temperature display button : Displays the room temperature. Also changes unit from °C to °F if pressed for 5 seconds.
		Timer button : Sets the current time and the start / end time.
		Navigation and functions button* : Adjusts the time and sets the special functions. 🧹: Auto clean / 🕒: Operates energy saving cooling / LIGHT: Adjusts the brightness of the indoor unit display
	-	Set/clear button : Sets or cancels functions.
	-	Reset button : Resets the air conditioner settings.

* Some functions may not be supported, depending on the model.

Inserting batteries

Insert batteries before using the remote control. The battery type used is AAA (1.5 V).

- 1 Remove the battery cover.

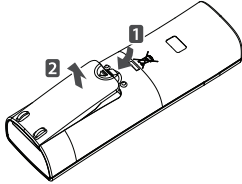

- 2 Insert the new batteries and make sure that the + and - terminals of the batteries are installed correctly.

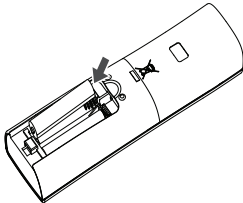

- 3 Reattach the battery cover.

! NOTE

If the display screen of the remote control starts to fade, replace the batteries.

Installing the remote control holder

Install the holder where there is no direct sunlight to protect the remote control.

- 1 Choose a safe and easily-accessible place.

- 2 Fix the holder by fastening the 2 screws firmly with a screwdriver.

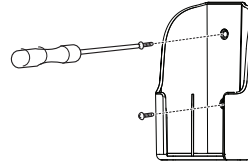

- 3 Slide the remote control into the holder.

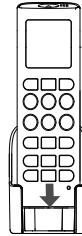

Operating method

Point the remote control towards the signal receiver at the bottom of the air conditioner to operate it.

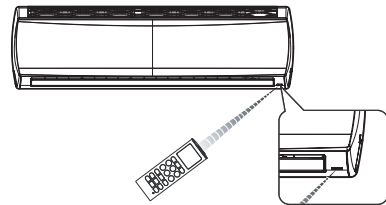



! NOTE

- The remote control may operate other electronic devices if pointed towards them. Make sure to point the remote control towards the signal receiver of the air conditioner.
- For proper operation, use a soft cloth to clean the signal transmitter and receiver.



BASIC FUNCTIONS

Cooling your room

(Cooling operation)

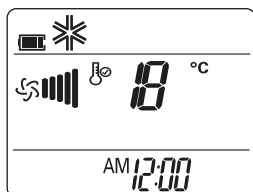

- 1 Press  to turn on the power.
- 2 Press  repeatedly to select the cooling operation.
- ❄️ is displayed on the display screen.





- 3 Press  or  to set the desired temperature.
- The temperature range is 18°C - 30°C.

Heating your room

(Heating operation)

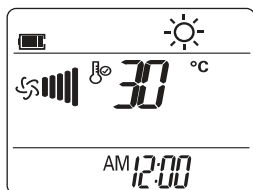
- 1 Press  to turn on the power.
- 2 Press  repeatedly to select the heating operation.
- ☀️ is displayed on the display screen.



- 3 Press  or  to set the desired temperature.
- The temperature range is 16°C - 30°C



! NOTE

Cooling-only models do not support this function.

Removing humidity

(Dehumidifying operation)

This mode removes excess moisture from an environment with high humidity or in the rainy season, in order to prevent mold from setting in. This mode adjusts the room temperature and the fan speed automatically to maintain the optimal level of humidity.

- 1 Press  to turn on the power.
- 2 Press  repeatedly to select the dehumidifying operation.
- 💧 is displayed on the display screen.

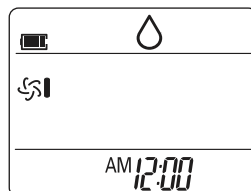





! NOTE

- In this mode you cannot adjust the room temperature, as it is adjusted automatically. Also, the room temperature is not displayed on the display screen.

Airing your room (Air Circulation operation)

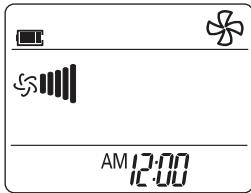

This mode only circulates the indoor air without changing the room temperature.

- 1 Press  to turn on the power.
- 2 Press  repeatedly to select the air circulation operation.
Or press  to select the air circulation operation.
-  is displayed on the display screen.





- 3 Press  to adjust the fan speed.

Adjusting the fan speed

- 1 Press  repeatedly to adjust the fan speed.
- Select  if you want natural air.
The fan speed adjusts automatically.

Adjusting the air flow direction

- 1 To adjust the direction of the air flow vertically, press  repeatedly and select the desired direction.
- Select  to adjust the direction of the air flow automatically.

! NOTE

- Adjusting the air deflector arbitrarily may cause product failure.
- If you restart the air conditioner, it starts to operate with the previously set direction of air flow, so the air deflector may not match the icon displayed on the remote control. When this occurs, press  to adjust the direction of the air flow again.



Setting the timer

You can use the timer function to save energy and to use the air conditioner more efficiently.

Setting the current time

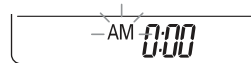
- 1 Press  and hold it for longer than 3 seconds.
- The AM/PM icon flickers at the bottom of the display screen.



- 2 Press  or  to select the minutes.
- 3 Press  to finish.

Turning on the air conditioner automatically at a set time

- 1 Press **ON**.
- The icon below flickers at the bottom of the display screen.

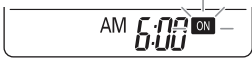

- 2 Press **▽** or **△** to select the minutes.
- 3 Press **SET/CLEAR** to finish.

Turning off the air conditioner automatically at a set time

- 1 Press **OFF**.
- The icon below flickers at the bottom of the display screen.

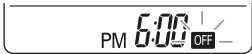

- 2 Press **▽** or **△** to select the minutes.
- 3 Press **SET/CLEAR** to finish.

Canceling the timer setting

- 1 Press **ON**.
- 2 Press **ON** or **OFF** to select the timer setting to cancel.
- 3 Press **SET/CLEAR**.
- To cancel all timer settings, press **SET/CLEAR**.

Setting sleep mode

Use the sleep mode to turn off the air conditioner automatically when you go to sleep.

- 1 Press **SLEEP** to turn on the power.
- 2 Press **SLEEP**.
- 3 Press **▽** or **△** to select the hour (up to 7 hours).
- 4 Press **SET/CLEAR** to finish.
- **SLEEP** is displayed on the display screen in sleep mode.

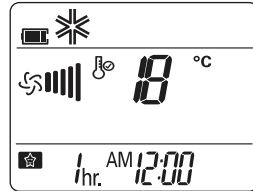

NOTE



In the Cooling and Dehumidifying modes, the temperature increases by 1°C after 30 minutes and by a further 1°C after another 30 minutes for a more comfortable sleep. The temperature increases with up to 2°C from the preset temperature.

ADVANCED FUNCTIONS

The air conditioner offers some additional advanced functions.

Changing room temperature quickly (Jet Cool/Heat operation)

This mode allows you to cool indoor air quickly in summer or warm it quickly in winter.

- 1 Press  to turn on the power.
- 2 Press .

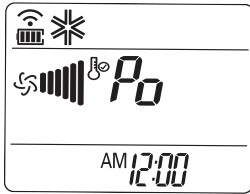

- In jet cooling mode, strong air blows out at a temperature of 18°C for 30 minutes.
- In jet heating mode, strong air blows out at a temperature of 30°C for 30 minutes.



! NOTE

- In Air Circulation, Auto, or Auto Changeover mode, this function cannot be used.
- This function may not be supported, depending on the model.

Indoor air purification

Auto Clean operation

In the cooling and dehumidifying operations, moisture is generated inside the indoor unit. Use the auto cleaning function to remove such moisture.

- 1 Press  to turn on the power.
 - 2 Press .
-  is displayed on the display screen.

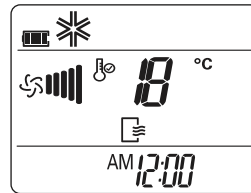



- If you turn off the power, the fan operates for 30 minutes and cleans the inside of the indoor unit.

! NOTE

Some buttons cannot be used while the auto cleaning function is in operation.

Auto Changeover Mode (Artificial intelligence)

You can set desired temperature and indoor fan speed. Setting Temp. Range : 18~30°C

- 1 Press  to turn on the power.
- 2 Press  repeatedly to select auto operation.

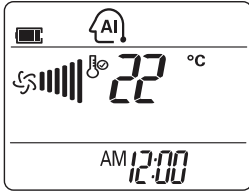

NOTE

- In this mode, you can set the air deflector to rotate automatically.
- This function may not be supported, depending on the model.

Display screen brightness

You can adjust the brightness of the indoor unit display screen.

- 1 Press  or  repeatedly to set the brightness to the desired level.

NOTE

This function may not be supported, depending on the model.

Operating the air conditioner without the remote control

You can use the On/Off button of the indoor unit to operate the air conditioner when the remote control is unavailable. However, the fan speed is set to high.

- 1 Open the front cover.
 - Lift up both sides of the cover slightly.

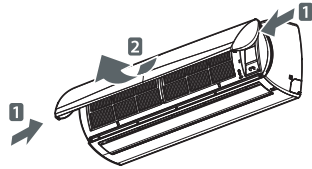

* The feature can be changed according a type of model.

- 2 Press the On/Off button.

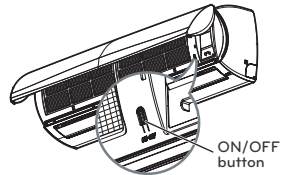

* The feature can be changed according a type of model.

- For cooling and heating models, the operation mode changes, depending on the operation mode of outdoor unit.

Restarting the air conditioner automatically

When the air conditioner is turned on again after a power failure, this function restores the previous settings. This function is a factory default setting.

Disabling auto restart

- 1 Open the front cover.
 - Lift up both sides of the cover slightly.

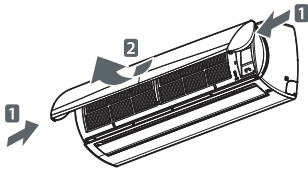

* The feature can be changed according a type of model.

- 2 Press the On/Off button and hold it for 6 seconds.
 - The unit will beep twice and the lamp will blink 6 times.

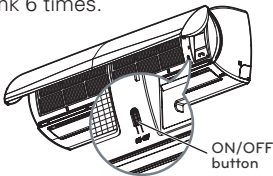

* The feature can be changed according a type of model.

- To re-enable the function, press the On/Off button and hold it for 6 seconds. The unit will beep twice and the blue lamp will blink 4 times.

! NOTE

If you press and hold the On/Off button for 3 – 5 seconds instead of 6 seconds, the unit will switch to the test operation. In the test operation, the unit blows out strong air for cooling for 18 minutes and then returns to the factory default settings.

Mode Lock setting

You can select operation mode for “cooling only” or “heating only”.

- 1 Press this for 5 seconds or more, operation mode changed to “cooling only”
- 2 Press this for 5 seconds or more, operation mode changed from “cooling only” to “heating only”.
- 3 Press this for 5 seconds or more, “heating only” mode released.
 - In “cooling only” or “heating only” mode, mode change cannot be choose.

! NOTE

Use other controller but wireless one, you can change operation mode.

MAINTENANCE

Clean the product regularly to maintain optimal performance and to prevent possible breakdown.

* This may not be provided, depending on the model.

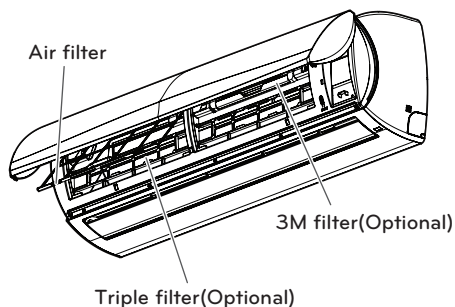

* The feature can be changed according to type of model.

Item	Cleaning interval	Cleaning method
Air filter	2 weeks	See "Cleaning Air filter."
Triple Filter	3 months	See "Cleaning Triple Filter. "
3M filter	1 months	See "Cleaning 3M filter."
Indoor unit surface	Regularly	Use a soft, dry cloth. Do not use bleach or abrasives.
Outdoor unit	Regularly	Use steam to clean the heat exchanger coils and the panel vents (consult with technician).

! CAUTION

- Turn off the power and unplug the power cord before you perform any maintenance; otherwise it may cause electric shock.
- Never use water that is hotter than 40°C(104°F) when you clean the filters. It may cause deformation or discoloration.
- Never use volatile substances when you clean the filters. They may damage the surface of the product.
- Do not washed the 3M filter with water, because the filter can be damaged.

! NOTE

- The location and shape of the filters may differ, depending on the model.
- Make sure to clean the heat exchanger coils of the outdoor unit regularly, as dirt collected in the coils may decrease the operational efficiency or increase energy costs.

Cleaning the Dual Protection Filter

Clean the dual protection filter once every 2 weeks or more if necessary.

- 1 Turn off the power and unplug the power cord.
- 2 Open the front cover.
 - Lift up both sides of the cover slightly.

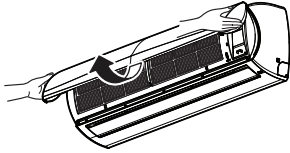

* The feature can be changed according to type of model.

- 3 Hold the knob of the dual protection filter, lift it up slightly and remove it from the unit.

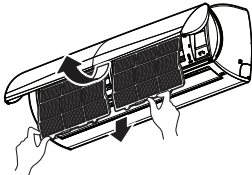

* The feature can be changed according to type of model.

- 4 Clean the filter with a vacuum cleaner or with warm water.
 - If dirt is difficult to remove, wash the filter in lukewarm water with detergent.
- 5 Dry the filter in the shade.

Cleaning the Triple filter (Optional)

- 1 Turn off the power and unplug the power cord.
- 2 Open the front cover and remove the air filter (see "Cleaning air filter").
- 3 Pull out the Triple Filter.

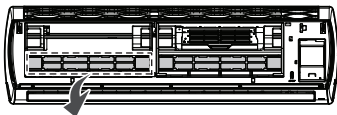

- 4 Use a vacuum cleaner to remove dirt, Do not wash the Triple filter with water, because the filter can be damaged.

! NOTE

- We suggest changing the Triple filter every 6 Months.
- The location of the filters may differ, depending on the model.
- If you need more filters, please contact the LG service center (Refer to the warranty card.)

Cleaning the 3M filter (Optional)

- 1 Turn off the power and unplug the power cord.
- 2 Open the front cover and remove the air filter (see "Cleaning air filter").
- 3 Pull out the 3M filter.



* The feature can be changed according to type of model.

- 4 Use a vacuum cleaner to remove dirt, Do not wash the 3M filter with Water, because the filter can be damaged.

! NOTE

- We suggest changing the 3M filter every 6 Months.
- The location of the filters may differ, depending on the model.
- If you need more filters, please contact the LG service center (Refer to the warranty card.)

TROUBLESHOOTING

Self-diagnosis function

This product has a built-in self-diagnosis function. If an error occurs, the lamp of the indoor unit will blink in 2 second intervals. If this occurs, contact your local dealer or service center.

Before requesting service

Please check the following before you contact the service center. If the problem persists, contact your local service center.

Problem	Possible causes	Corrective action
Abnormal operating conditions.	<ul style="list-style-type: none"> • There is a burning smell and a strange sound coming from the unit. 	<ul style="list-style-type: none"> • Turn off the air conditioner, unplug the power cord and contact the service center.
	<ul style="list-style-type: none"> • Water leaks from the indoor unit even when the humidity level is low. 	
	<ul style="list-style-type: none"> • The power cord is damaged or generating excessive heat. 	
	<ul style="list-style-type: none"> • A switch, a circuit breaker (safety, ground) or a fuse is not operated properly. 	
The air conditioner does not work.	<ul style="list-style-type: none"> • The air conditioner is unplugged. 	<ul style="list-style-type: none"> • Check whether the power cord is plugged into the outlet.
	<ul style="list-style-type: none"> • A fuse is blown or the power supply is blocked. 	<ul style="list-style-type: none"> • Replace the fuse or check if the circuit breaker has tripped.
	<ul style="list-style-type: none"> • A power failure has occurred. 	<ul style="list-style-type: none"> • Turn off the air conditioner when a power failure occurs. • When the power is restored, wait 3 minutes, and then turn on the air conditioner.
	<ul style="list-style-type: none"> • The voltage is too high or too low. 	<ul style="list-style-type: none"> • Check if the circuit breaker has tripped.
	<ul style="list-style-type: none"> • The air conditioner turned off automatically at a preset time. 	<ul style="list-style-type: none"> • Press the power button again.
	<ul style="list-style-type: none"> • Battery setting is wrong in the remote controller. 	<ul style="list-style-type: none"> • Is the battery inserted in Remoted controller? Is the battery inserted with the correct terminal (+)(-)? • Even if you check the upper lists, the air conditioner does not operate. Please replace new batteries.

Problem	Possible causes	Corrective action
The air conditioner does not generate cool air.	<ul style="list-style-type: none"> • Air is not circulating properly. 	<ul style="list-style-type: none"> • Make sure that there are no curtains, blinds or furniture blocking the front of the air conditioner.
	<ul style="list-style-type: none"> • The air filter is dirty. 	<ul style="list-style-type: none"> • Clean the air filter once every 2 weeks. • See “Cleaning Air Filter” for more information.
	<ul style="list-style-type: none"> • The room temperature is too high. 	<ul style="list-style-type: none"> • In summer, it may take some time to cool indoor air. • In this case, select the jet cool operation to cool indoor air quickly.
	<ul style="list-style-type: none"> • Cold air is escaping from the room. 	<ul style="list-style-type: none"> • Make sure that no cold air is escaping through ventilation points in the room.
	<ul style="list-style-type: none"> • The desired temperature is higher than the set temperature. 	<ul style="list-style-type: none"> • Set the desired temperature to a level lower than the current temperature.
	<ul style="list-style-type: none"> • There is a heating source nearby. 	<ul style="list-style-type: none"> • Avoid using a heat generator such as an electric oven or a gas burner while the air conditioner is in operation.
	<ul style="list-style-type: none"> • Air circulation operation is selected. 	<ul style="list-style-type: none"> • In the air circulation operation, air blows from the air conditioner without cooling or heating the indoor air. • Switch the operation mode to the cooling operation.
	<ul style="list-style-type: none"> • Outside temperature is too high. 	<ul style="list-style-type: none"> • The cooling effect may not be sufficient.
The air conditioner does not generate warm air.	<ul style="list-style-type: none"> • When the heating mode is started. • Vane is almost closed and air flow does not come out. • Even though outdoor unit is already begun to operate. 	<ul style="list-style-type: none"> • This symptom is normal. • Please wait until the unit is preparing warm air. • This function prepare to blow warm air.
	<ul style="list-style-type: none"> • Defrosting mode is being done in the outdoor unit. 	<ul style="list-style-type: none"> • In heating mode, ice/frost is built up on the coils when the outside temperature fall down. • This function remove a layer of frost on the coil. • Please wait until this operation is completed. It takes about 15 mins.
	<ul style="list-style-type: none"> • Outside temperature is too low. 	<ul style="list-style-type: none"> • The heating effect may not be sufficient.

Problem	Possible causes	Corrective action
The air-conditioner stops during operation.	<ul style="list-style-type: none"> The air conditioner is suddenly turn off. 	<ul style="list-style-type: none"> The timer function could be operated. If the timer function would operate, the air-conditioner can be turn off. Check the timer setting is correct.
	<ul style="list-style-type: none"> A power failure has occurred during operation. 	<ul style="list-style-type: none"> There is the Auto Restart Function. It is a default setting. This function can turn on the unit automatically when the power is restored. If you live in frequent power failure area, this function would be useful.
Indoor unit is still operating even when the power is being turned off.	<ul style="list-style-type: none"> Auto-Clean mode is being operated. This function is to remove the rest of moisture indoor unit. 	<ul style="list-style-type: none"> Please, wait until the end of functions. It will be inhibit a fungal growth. If you do not want this feature, you can turn off to press .
Mist is discharged from the air outlet of the indoor unit.	<ul style="list-style-type: none"> The cooled air from the air conditioner makes mist. 	<ul style="list-style-type: none"> When the room temperature is down, this phenomenon will disappear.
Water leaks from the outdoor unit.	<ul style="list-style-type: none"> In the heating operations, condensed water drop from the heat exchanger. 	<ul style="list-style-type: none"> This symptom need to install drain hose under the base pan. Contact the installer.
Operating noise or vibration.	<ul style="list-style-type: none"> Clicking sound Clicking sound can be heard either when the unit starts or stops due to movement of reversing valve. Creaking sound The plastic parts of the indoor unit make sound of shrinks and expands due to a sudden temperature change. The water flowing sound, Blowing sound The flow of refrigerant through the air conditioner is switching, noise can be heard. 	<ul style="list-style-type: none"> These are normal symptoms. After a moment, it will be silent.
The indoor unit gives out odor.	<ul style="list-style-type: none"> The air smells bad because a musty or cigarettes odor may be absorbed into the indoor unit and discharged with airflow. 	<ul style="list-style-type: none"> If the smell does not disappear, you need to wash filter or heat exchanger. Contact the installer.

